

Mens 35-39

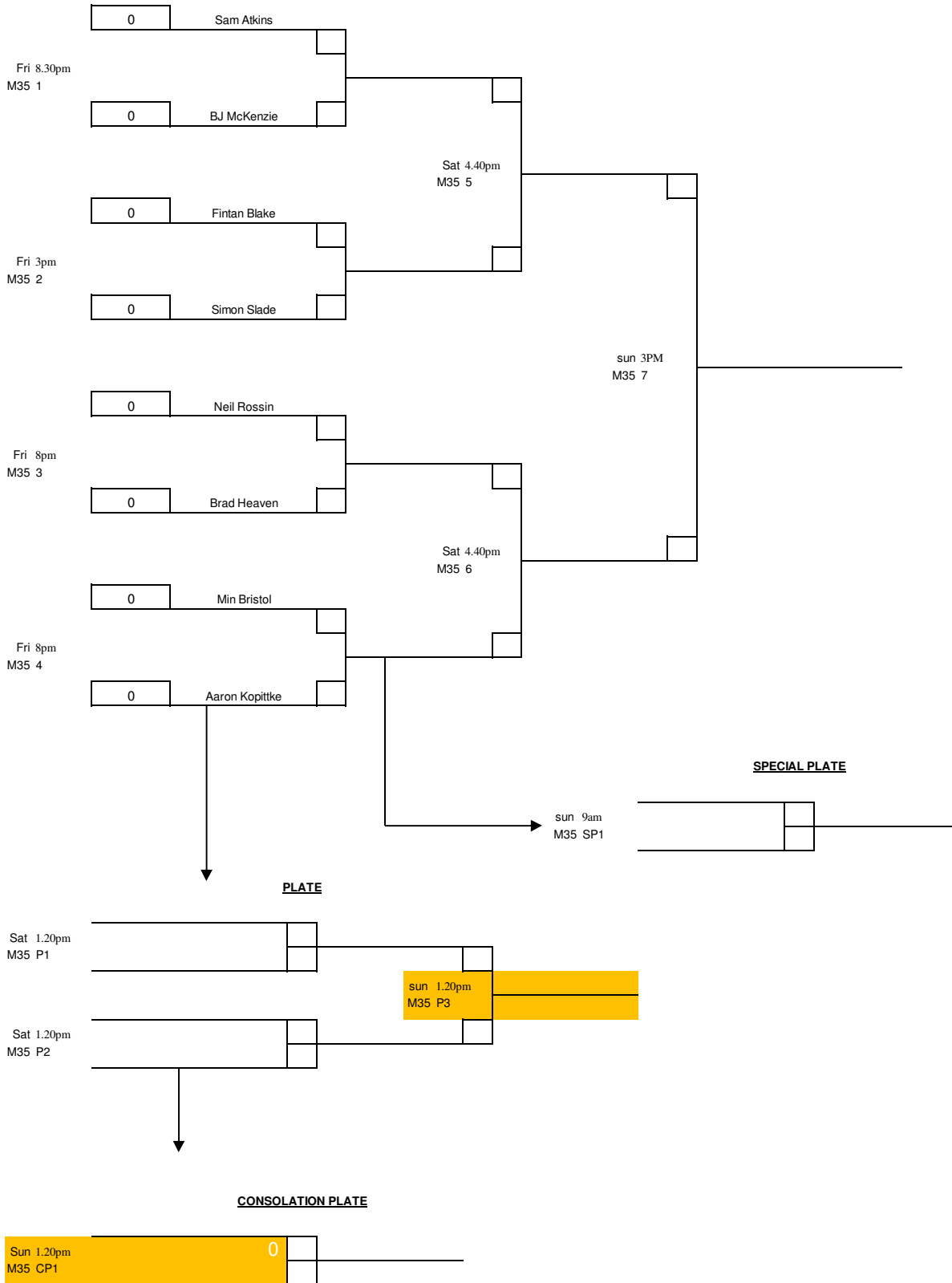

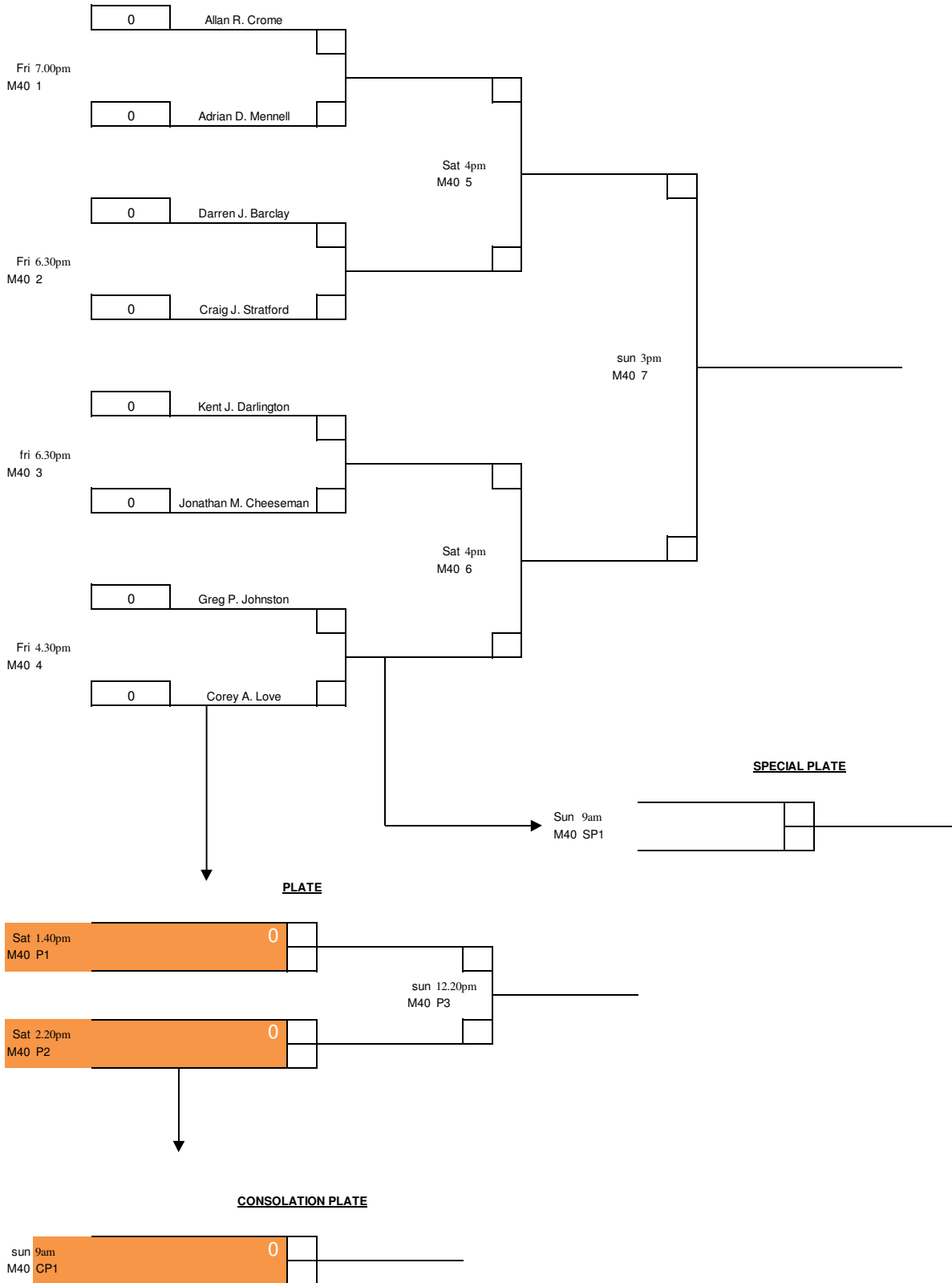

Mens 40-44





Mens 45-49

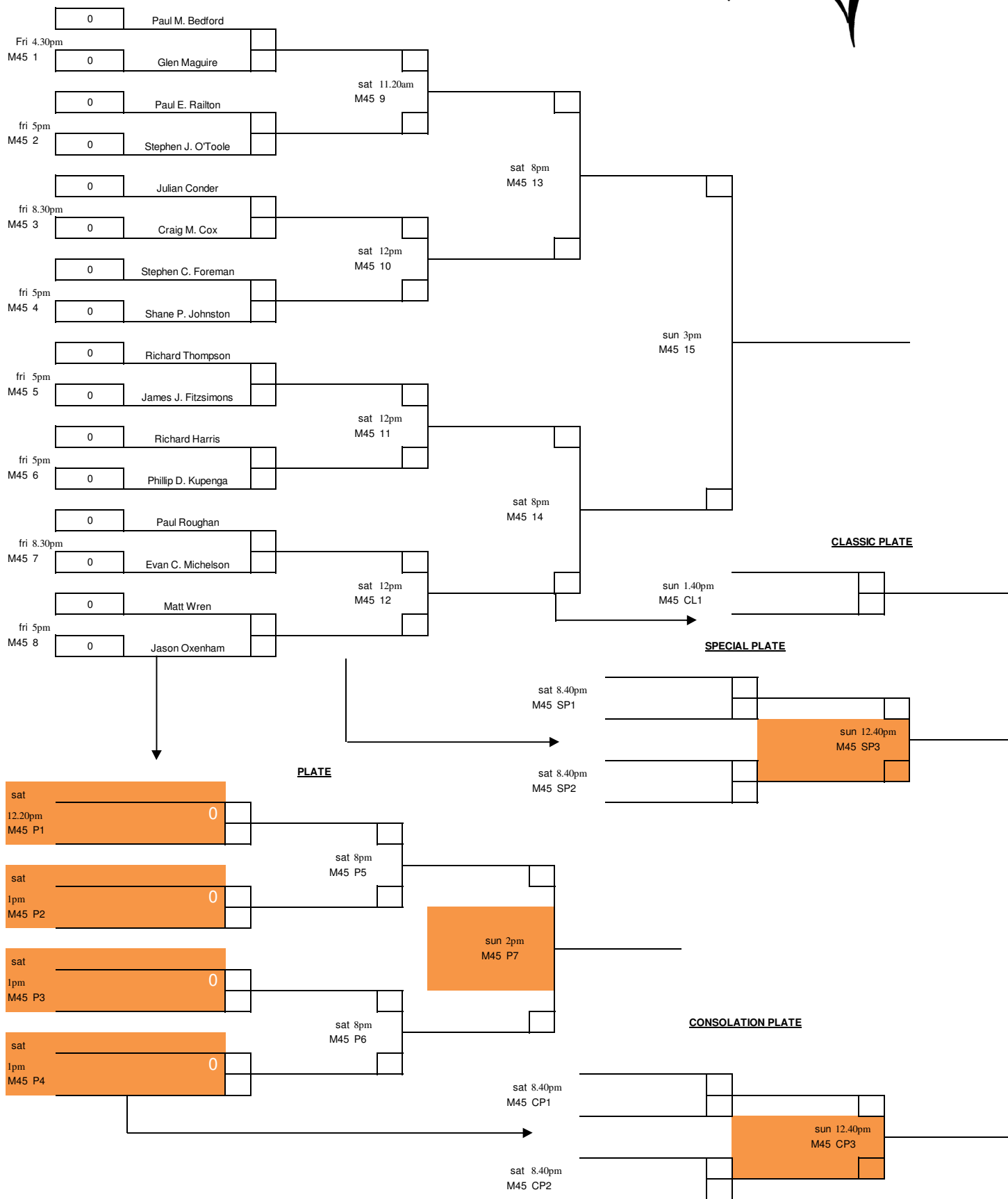



Mens 50 -54

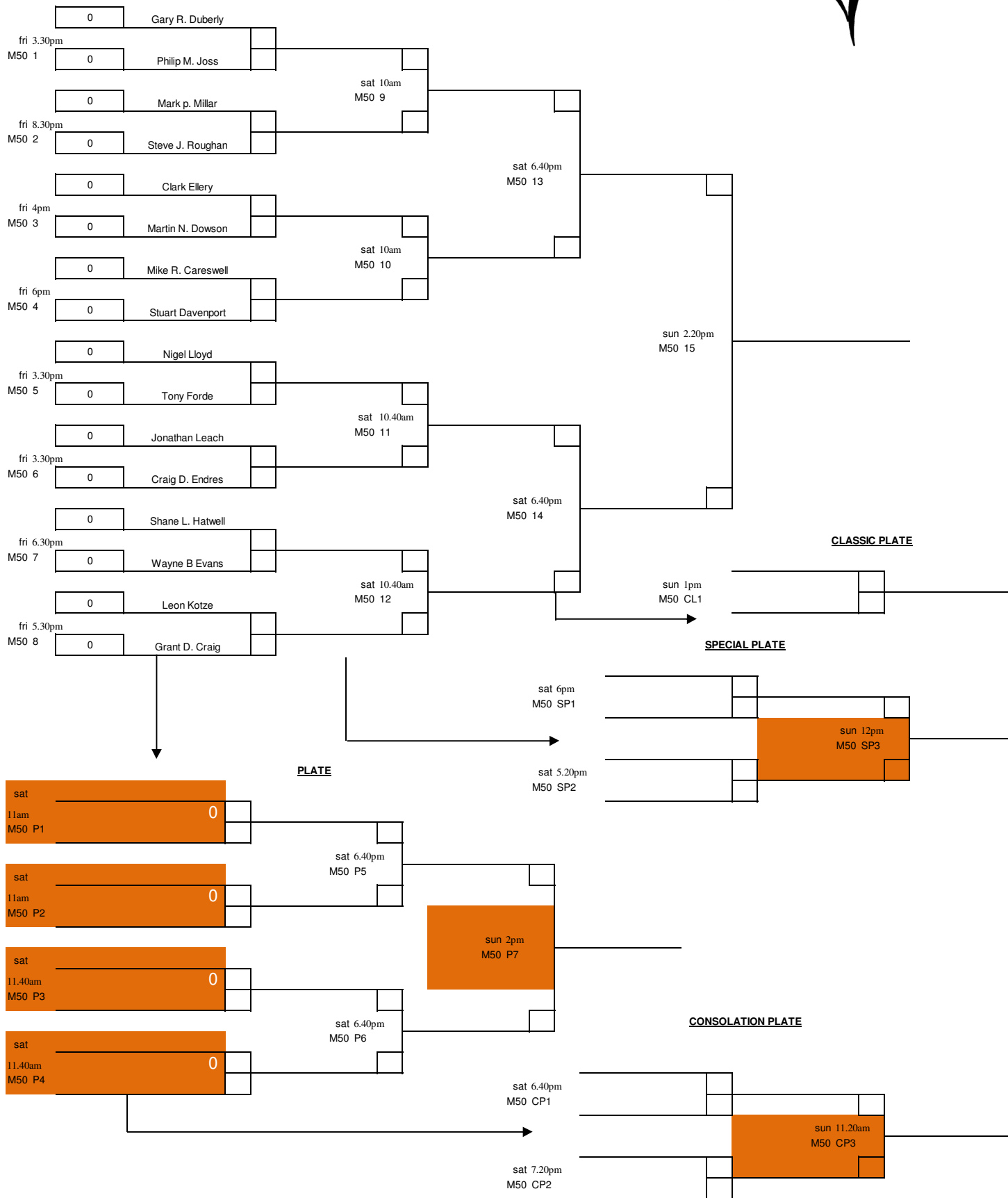



Mens 55-59

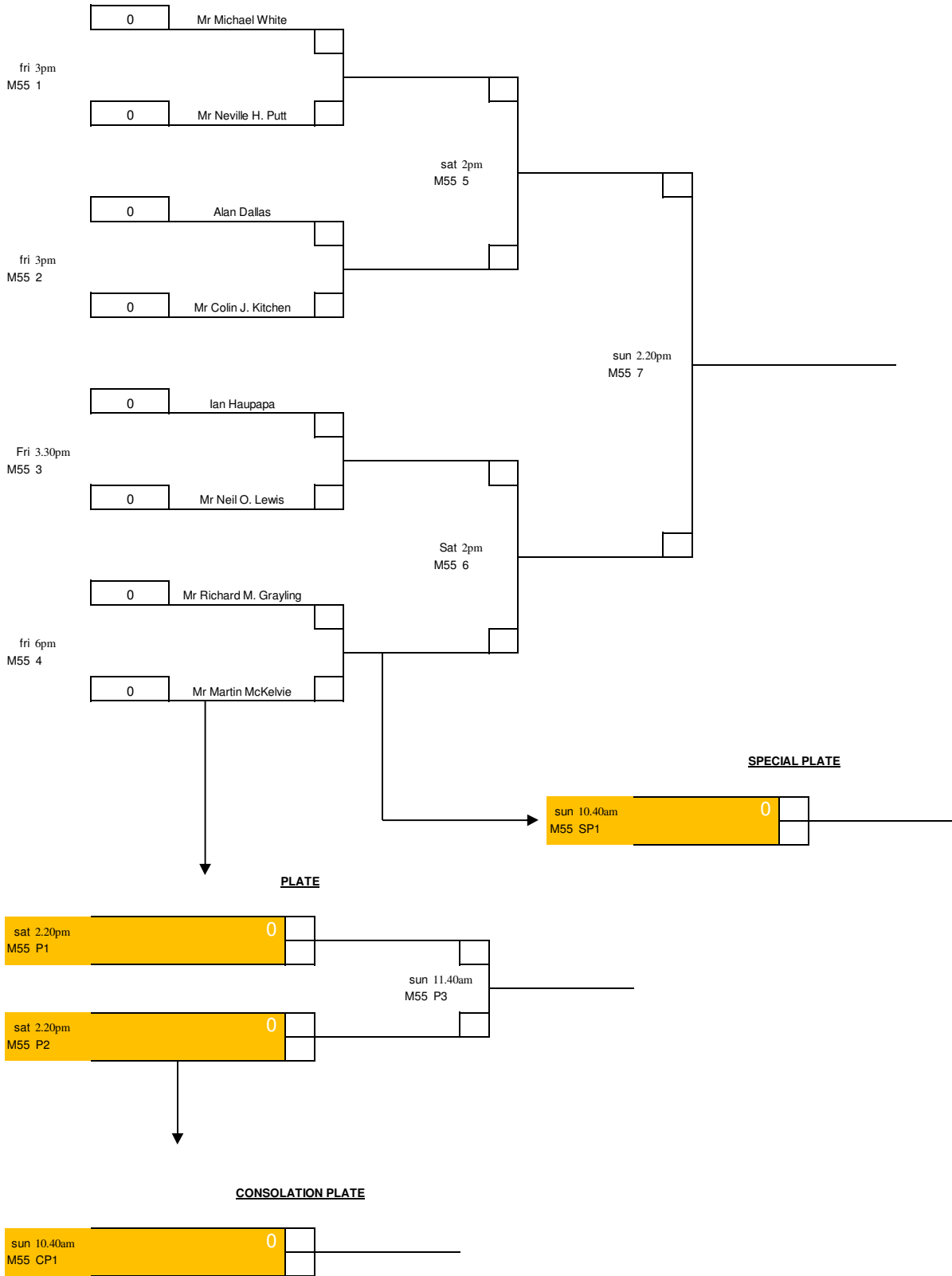

Mens 60-64

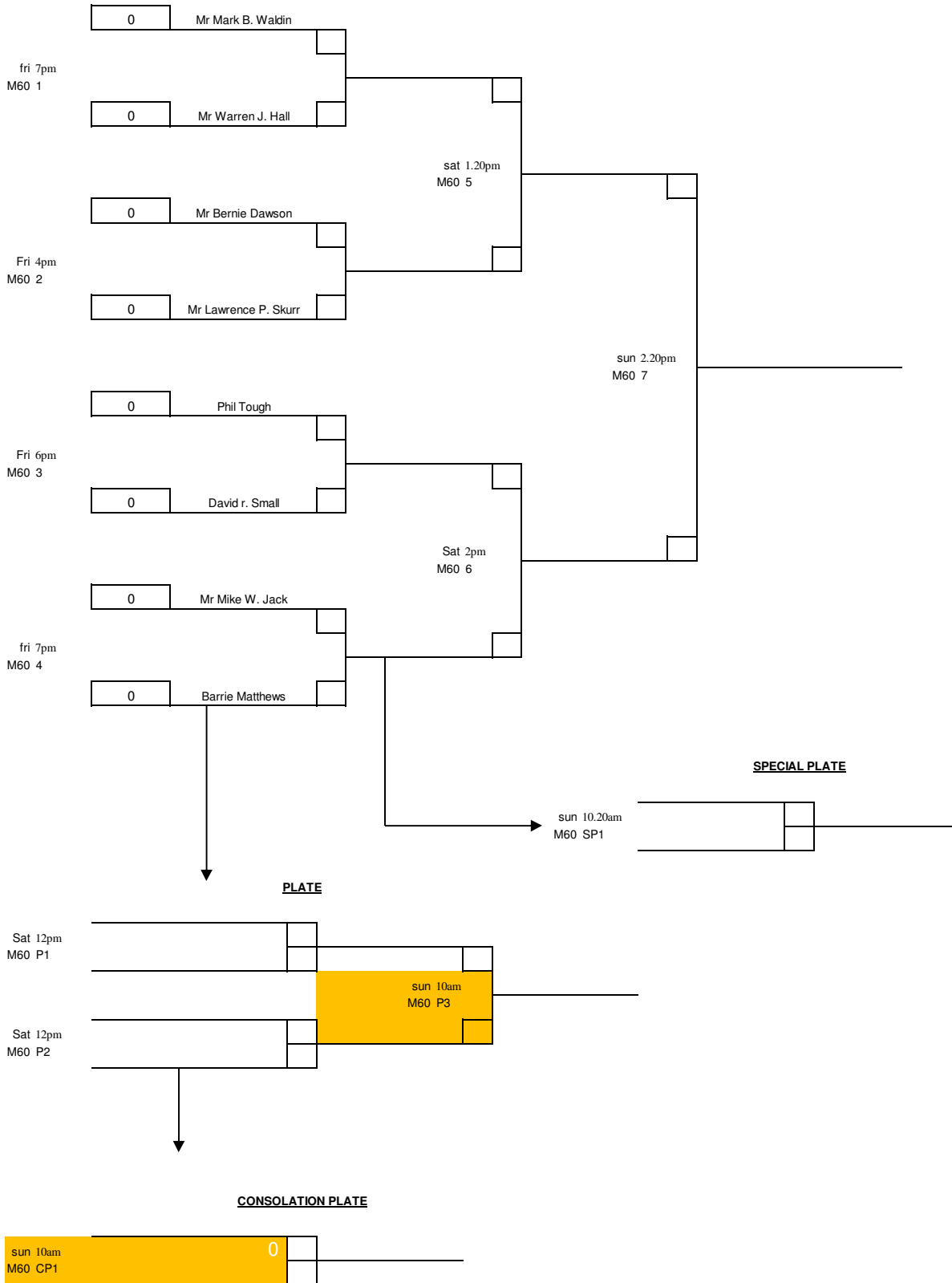

Mens 65-69

	Code	Name
1	0	Mr Wayne Seebeck
2	0	Mr Hongi Laing
3	0	Mr Ross Wells
4	0	Mr Peter Heagney
5	0	Colin Devcich
6	0	Mr Barry Hughes

fri 7.30pm
M65 C1

Mr Wayne Seebeck	/ / / / /	
Mr Barry Hughes		

fri 8pm
M65 C2

Mr Hongi Laing	/ / / / /	
Colin Devcich		

fri 5.30pm
M65 C3

Mr Ross Wells	/ / / / /	
Mr Peter Heagney		

Winner of C1 v Winner of C3

sat 11.20am
M65 C4

	/ / / / /	

Loser of C2 v Loser of C3

sat 11.20am
M65 P1

	/ / / / /	

Winner of C2 v Winner of C3

sat 6pm
M65 C5

	/ / / / /	

Loser of C3 v Loser of C1

sat 6pm
M65 P2

	/ / / / /	

Winner of C1 v Winner of C2

sun 12.20pm
M65 C6

	/ / / / /	

Loser of C3 v Loser of C2

sun 10.20am
M65 P3

	/ / / / /	

Winner _____

Runner up _____

Plate _____

HOME

Calculate

kawaroa park SQUASH CLUB

Mens 70+ and 75+



Code	Name	Code	Name
0	Mr Richard Purser	0	Mr Graeme Richardson
0	john rowell	0	Mr Trevor J. Coulter
0	Len F. Stachurski	0	Mr Owen A. Bunn

Mr Richard Purser		//////
fri 7pm	0	
M70+ 1	Len F. Stachurski	

trevor coulter		//////
fri 7.30pm	0	
M70+ 1	Mr Owen A. Bunn	

len stachurski		//////
sat 10am		
M70+ 1	Mr Trevor J. Coulter	

Mr Graeme Richardson		//////
fri 6.30pm		
M70+ 1	john rowell	

richard purser		//////
sat 10am		
M70+ 1	owen bunn	

John Rowell		//////
sat 5.20pm		
M70+ 1	Mr Owen A. Bunn	

Graeme richardson		//////
sat 5.20pm		
M70+ 1	Richard purser	

owen bunn		//////
sun 9.40am		
M70+ 1	Len stachurski	

john rowell		//////
sun 9.40am		
M70+ 1	Mr Trevor J. Coulter	

Graeme Richardson		//////
sun 1.40pm		
M70+ 1	Len Stachurski	

Richard Purser		//////
sun 2.20pm		
sat 1	Trevor Coulter	

Winner

Runner up

Third



Mens Division 1

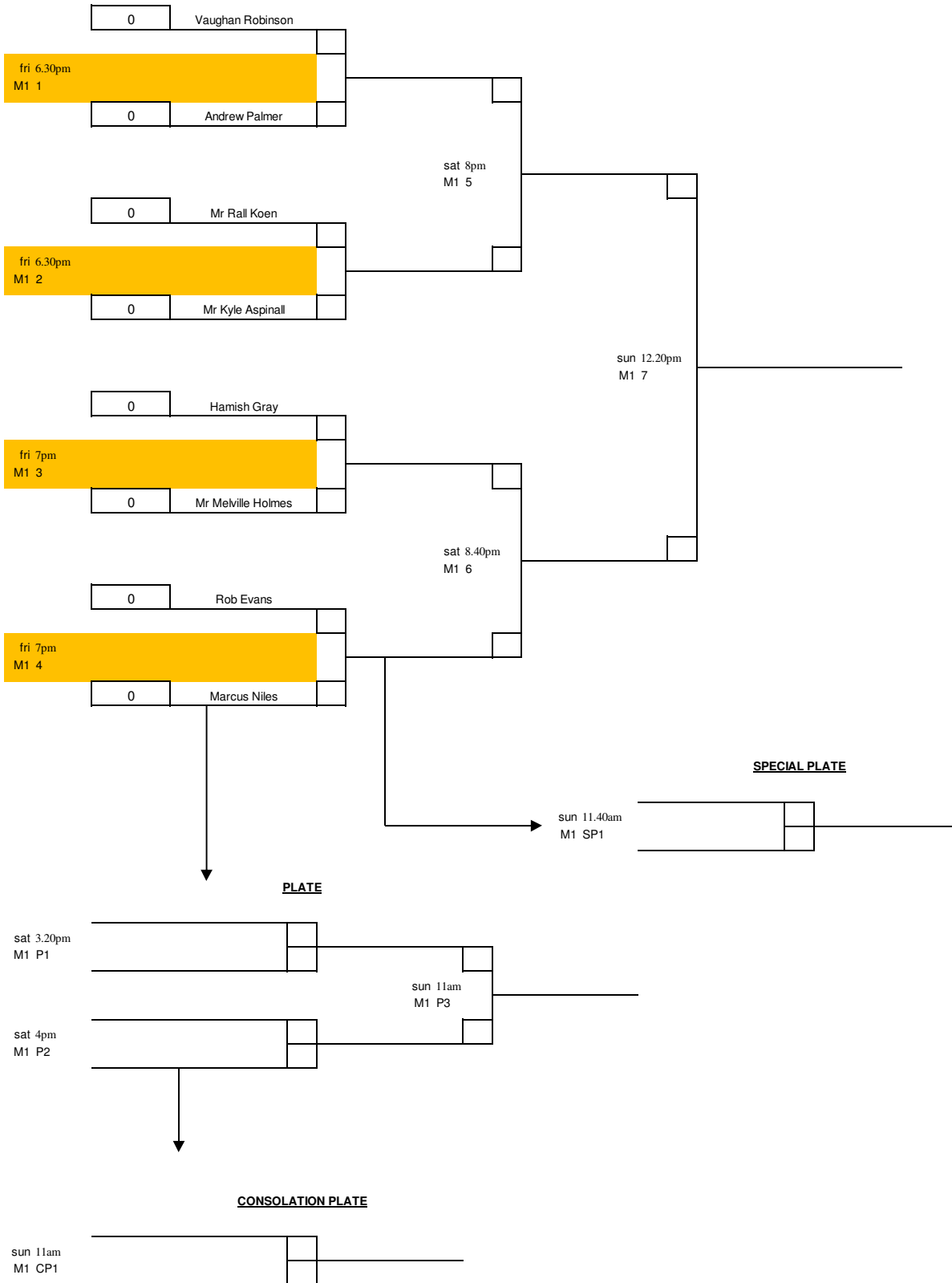



Mens division3

	Code	Name
1	0	Sean Fleming
2	0	Mr Kevin I. Jensen
3	0	Michael MacDonald
4	0	Steve A. Oldfield

fri 5.30pm M3 1	Sean Fleming	0	/ / / / /
	Steve A. Oldfield		

sat 9.30am M3 1	Sean Fleming		/ / / / /
	Michael MacDonald		

fri 6pm M3 1	Mr Kevin I. Jensen	0	/ / / / /
	Michael MacDonald		

sat 9.30am M3 1	Mr Kevin I. Jensen		/ / / / /
	Steve A. Oldfield		

sun 11.40am M3 1	Sean Fleming		/ / / / /
	Mr Kevin I. Jensen		

sun 11am M3 1	Michael MacDonald		/ / / / /
	Steve A. Oldfield		

Winner _____

Runner up _____

Third _____

HOME

Calculate



Womens 35-39

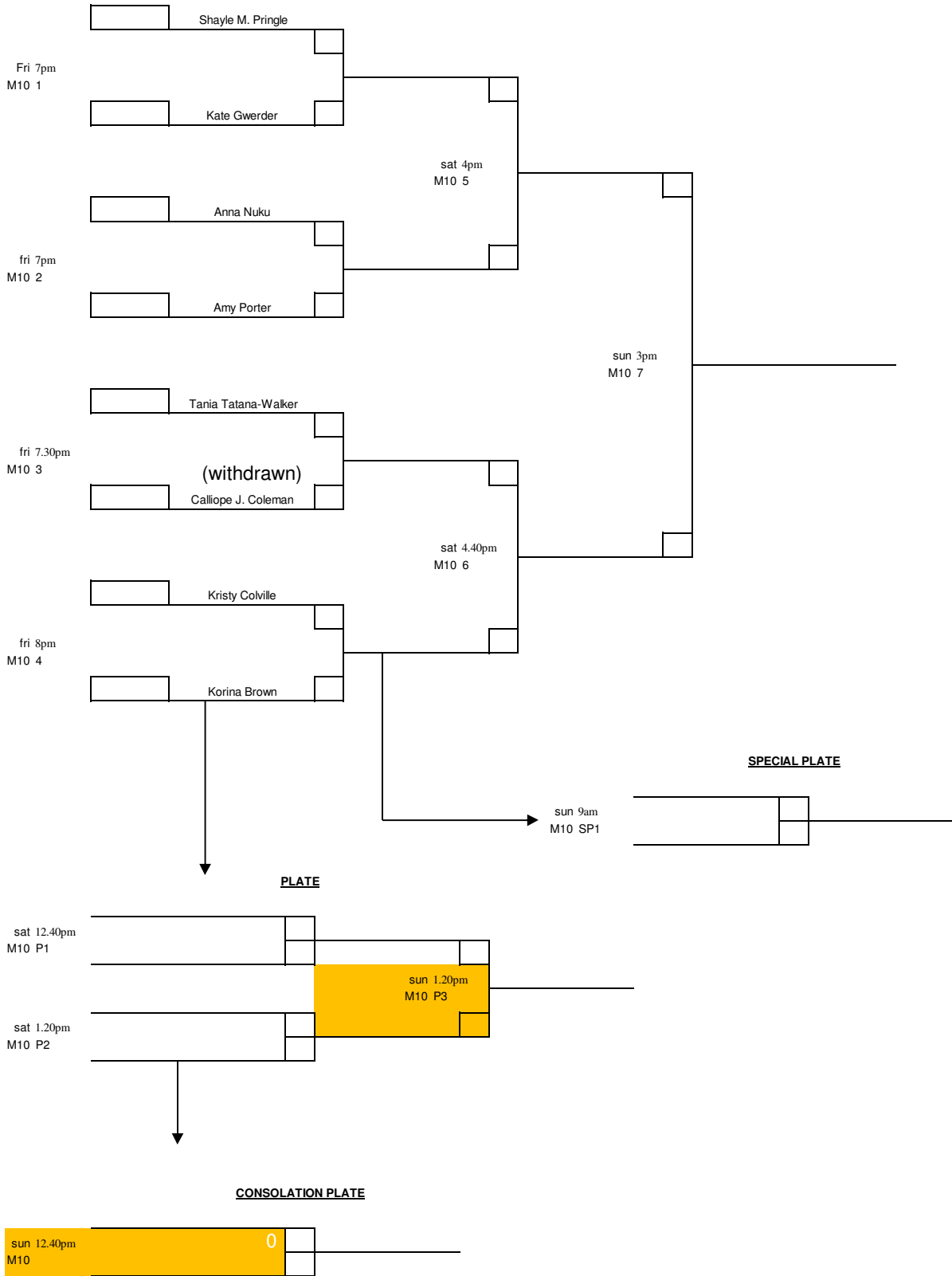



Womens 40-44

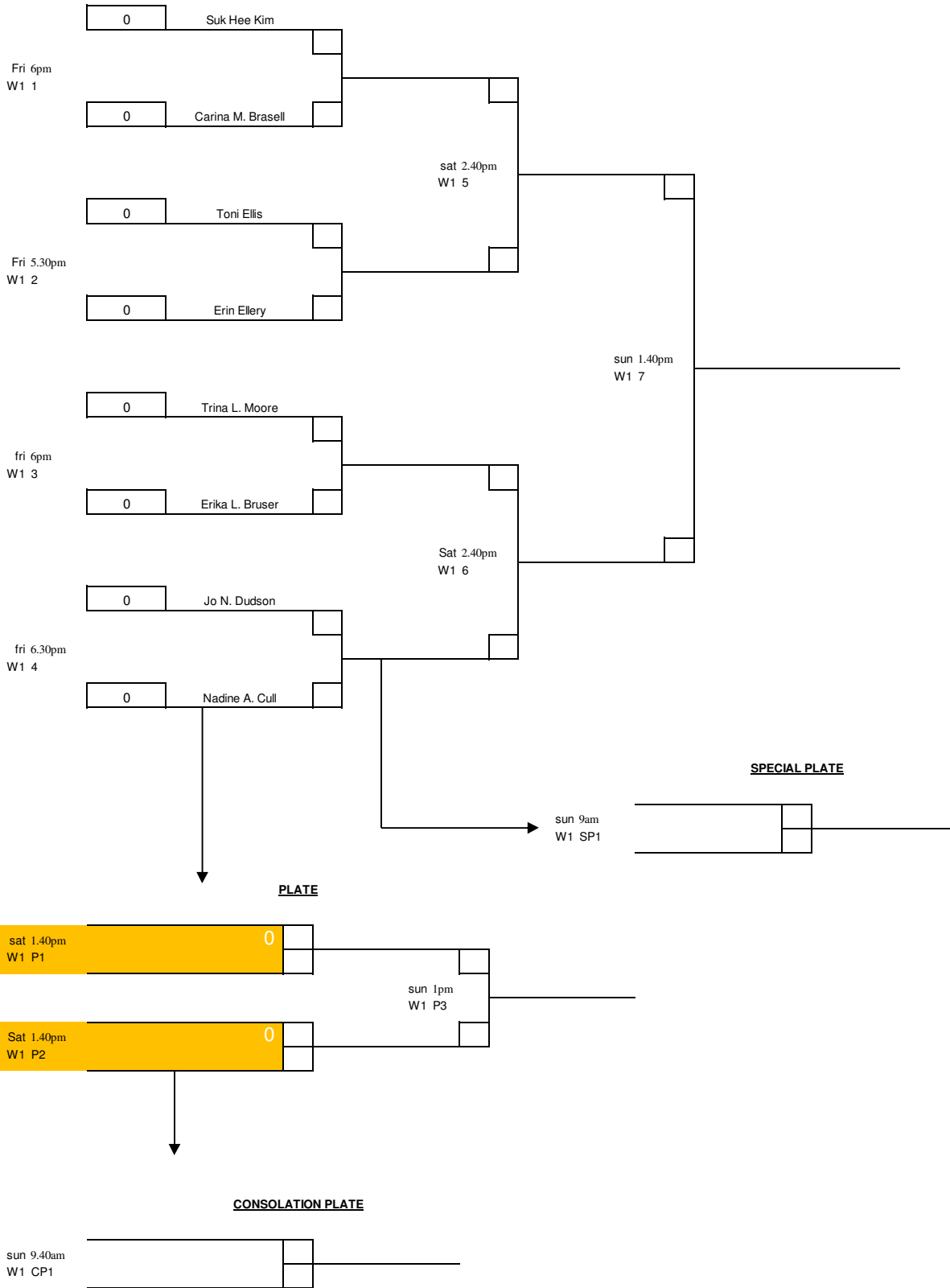



Womens 45-49

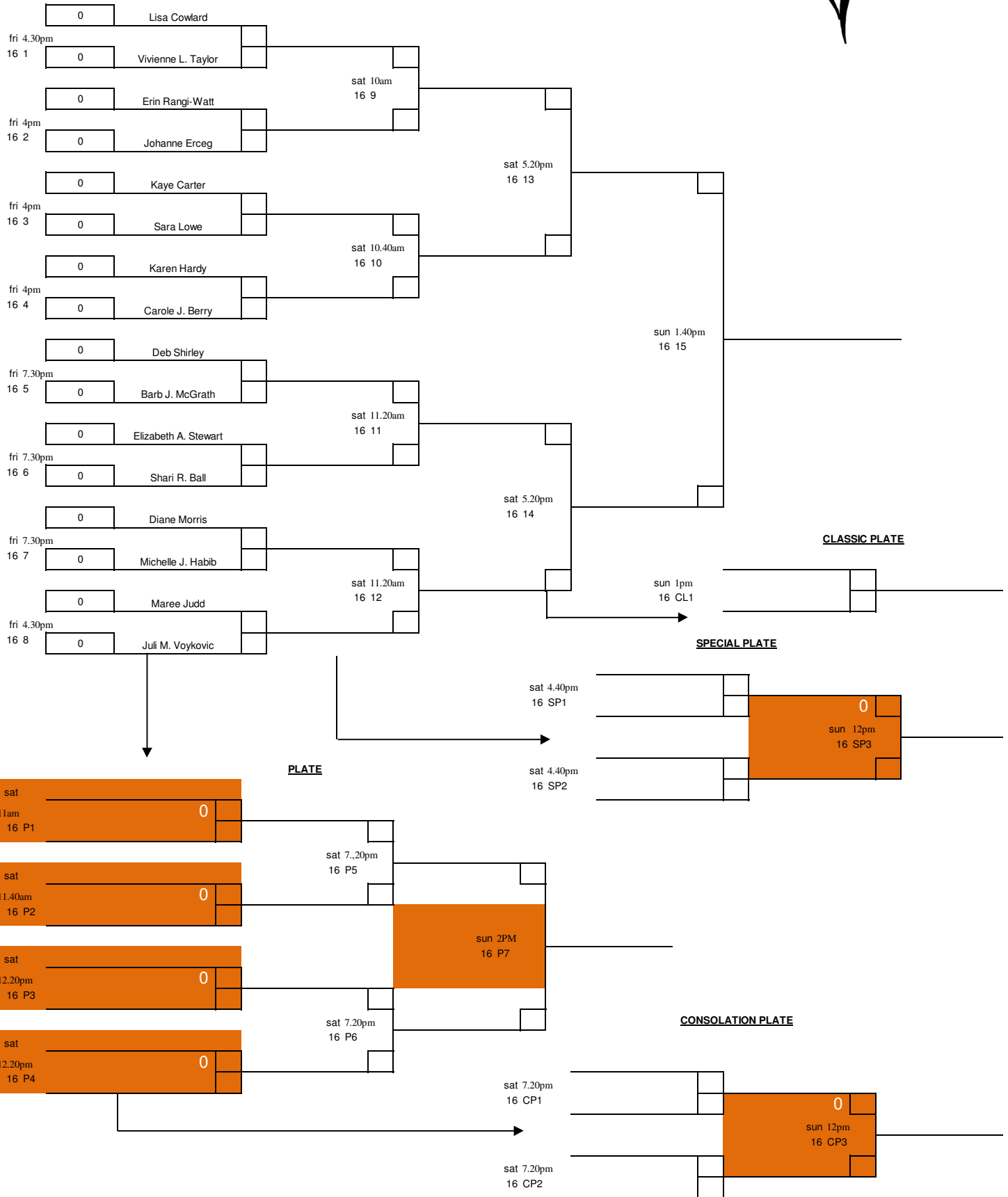

Womens 50-54

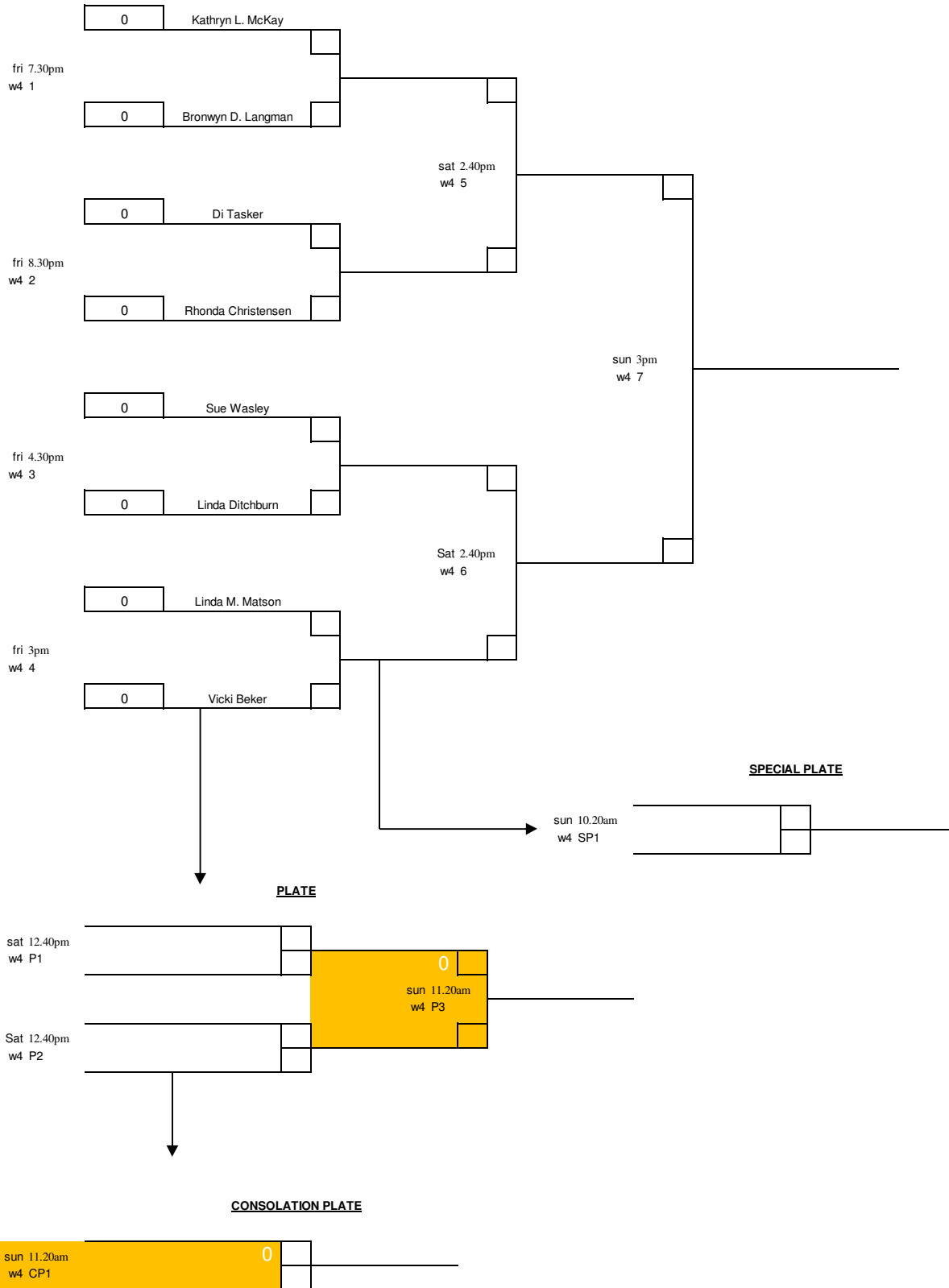



Womens 55-59

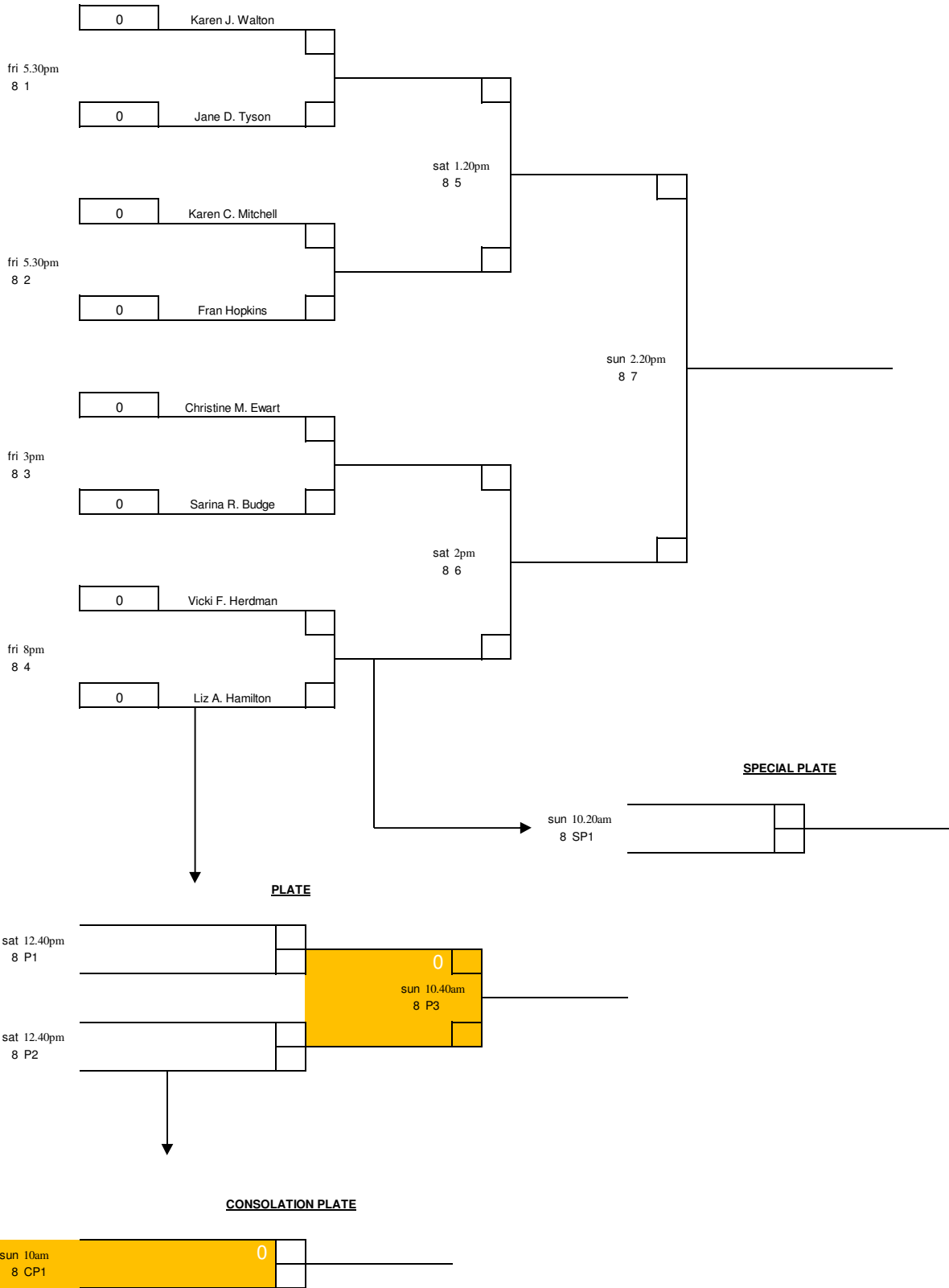



Womens 60-64

	Code	Name
1	0	Freda Walker
2	0	Sandra Lelievre
3	0	Janice I. Trevathan
4	CDKPXX4	bye

Day 10.00pm
4RR 1

Freda Walker	/ / / / /
bye	

fri 3.30pm
4RR 1

Freda Walker	/ / / / /
Janice I. Trevathan	

sat 4pm
4RR 1

Sandra Lelievre	/ / / / /
Janice I. Trevathan	

Day 0.0pm
4RR 1

Sandra Lelievre	/ / / / /
bye	

sun 12.20pm
4RR 1

Freda Walker	/ / / / /
Sandra Lelievre	

Day 0.0pm
4RR 1

Janice I. Trevathan	/ / / / /
bye	

Winner _____

Runner up _____

Third _____

HOME

Calculate